

ENSURING ANTITRUST COMPLIANCE FOR YOUR BUSINESS

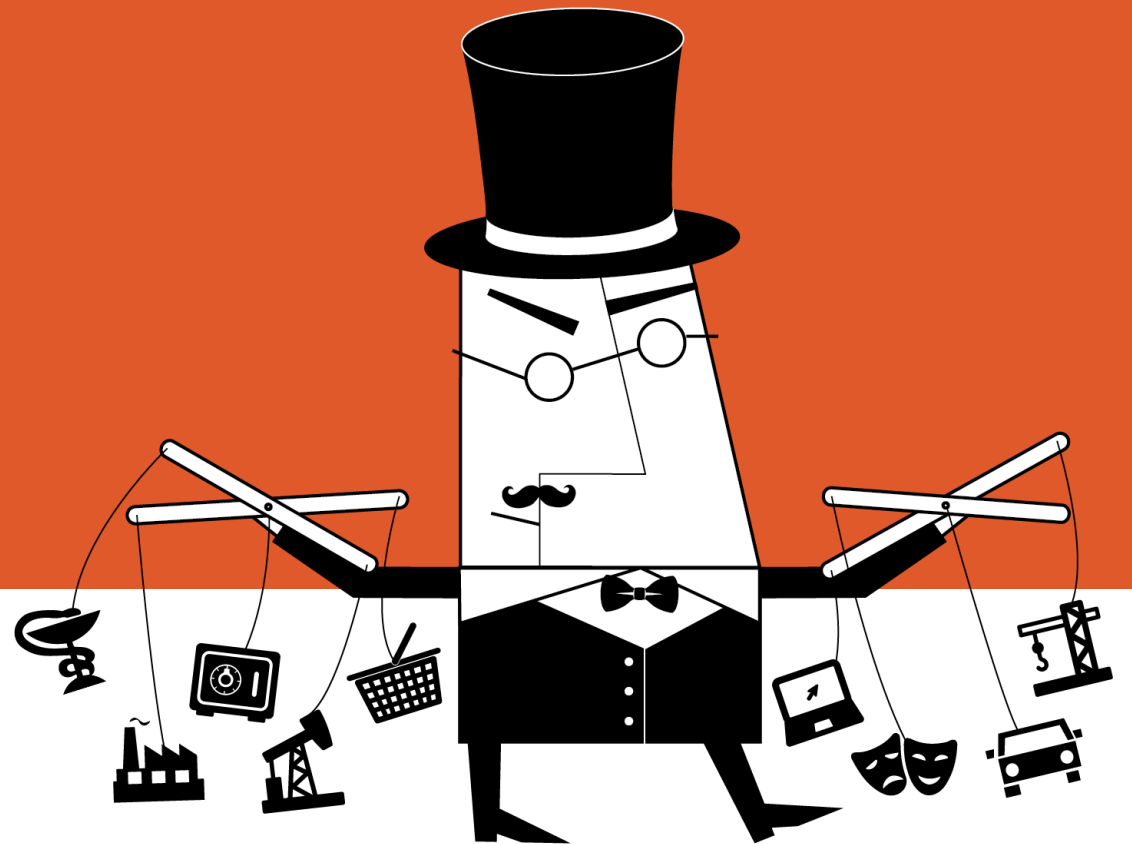

About the practice



The year when the practice was established.



Significant experience in cases involving the Federal Antimonopoly Service of Russia (FAS Russia) and the Eurasian Economic Commission as well as in handling violations of the law on foreign investments in strategic sectors.



Implemented over 1,500 projects.



Strongly focused on antitrust investigations.



Actively involved in developing and discussing amendments to antitrust legislation.



Regularly organise discussions with FAS Russia, the Eurasian Economic Commission, the Russian Supreme Court, the business community and experts.



100% of transactions have been approved as part of control over economic concentration and foreign investments in strategic sectors.



The first full-fledged antitrust compliance system on the market.



@PgAntitrust

The channel of Pepeliaev Group's Antitrust Practice and of the Competition and Law journal

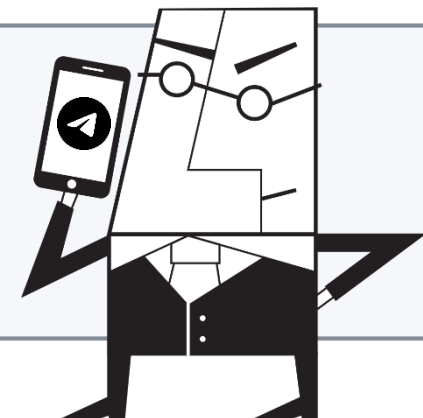

About the practice

Antitrust Practice in Ratings:



CHAMBERS
EUROPE

Clients per industry:



Industrial Production



Energy and Natural Resources



Retail



Pharmaceuticals and Healthcare



Banking, Finance and Insurance



Transport



Technology, Media, and Telecommunications



Real Estate & Construction



Social and Cultural



THE PRACTICE'S SERVICES AND PROJECTS



Antitrust audits and devising antitrust compliance systems

Performed legal due diligence in order to implement an antitrust compliance system

As part of an antitrust audit, Pepeliaev Group's lawyers performed due diligence with the intention of implementing a compliance system in an international group of pharmaceutical companies. The Practice's lawyers performed an in-depth analysis of the client's group of companies and produced a report assessing the risks identified and recommending how to mitigate them.

Prepared an expert opinion on how to develop an antitrust compliance system

Pepeliaev Group's lawyers performed an expert examination and identified significant defects in the antitrust compliance system developed by a third-party service provider under a government contract. The specialists of the Practice prepared a high-quality and detailed opinion which the client used as a ground for the government contract with the service provider to be unilaterally terminated. Subsequently, the client could adjust the antitrust compliance system developed in order to effectively prevent antitrust risks in its activity. This project is unique because our Antitrust Practice was the first to implement a project of this type on the market of legal services.

Developed and implemented a system of antitrust compliance for MTS

The firm's Antitrust Practice provided legal support to a major Russian mobile operator when it developed and implemented a compliance system. The project handled by Pepeliaev Group's lawyers for MTS was among the first of its kind in Russia. It is now positive illustrative case promoting the institution of antitrust compliance on the Russian market.

Performed an antitrust audit and evaluation of an existing antitrust compliance system

The Practice's lawyers performed an antitrust audit of a large Russian energy company in order to identify its business risks and to determine whether the existing antitrust compliance system was effective.

Advising on the application of antitrust legislation

Advised a client on whether a decision of FAS Russia was lawful

Pepeliaev Group's lawyers prepared a detailed opinion on whether a decision of FAS Russia was lawful and on whether the client (an energy company) could influence the amount of a newly approved electricity tariff. The resulting document helped the client to form a strategy of the subsequent development of the enterprise, taking into account the effect on the profit of the newly approved tariffs, and to develop the tactics for cooperation with the regional tariff authority when the newly approved tariff was established.

Provided integrated legal support for a major manufacturer of sports clothes and equipment

Our Antitrust Practice's lawyers provided integrated legal support to an international manufacturer of sports clothes and equipment in its day-to-day business operations. Pepeliaev Group's lawyers reviewed contracts from the standpoint of antitrust legislation. They also analysed the client's business model including its online sales model, and provided advice to it on Russian advertising legislation.

Advised a client on relationships with its dealers

The Practice's lawyers provided advice to a top international manufacturer of construction equipment regarding its relationships with its dealers, including the procedure for selecting potential dealers.



Analysing and devising internal corporate documents

Devised a draft trade policy and subsequently agreed it with FAS Russia

Pepeliaev Group's lawyers drafted and subsequently agreed with FAS Russia a trade policy relating to the wholesaling of various types of car petrol and diesel fuel for a major oil company. In this project our lawyers developed an integrated system of conditions for the wholesaling of oil products, the pricing for them and a list of requirements for counterparties intending to acquire car petrol and diesel fuel.

Analysed a commercial policy for compliance with Russian antitrust legislation

The team of Pepeliaev Group's Antitrust Practice analysed the commercial policy of a major healthcare company in terms of its compliance with Russian antitrust legislation. As part of the analysis, Pepeliaev Group's lawyers assessed whether the criteria for selecting distributors were justified and non-discriminatory; they also assessed the commercial conditions for cooperation with distributors in terms of the existing antitrust risks.

Advised the client on dealings with its distributors

Pepeliaev Group's lawyers advised a large international tobacco company on its dealings with its distributors. As part of the project our lawyers analysed the client's commercial policies and developed recommendations with regard to the procedure for selecting distributors, pricing matters, and the granting of bonuses. Our lawyers also analysed the distributor contracts and developed recommendations on how to improve the wording of these contracts in order to avoid antitrust risks.

Providing legal support for companies during FAS audits

Assisted a large pharmaceutical company in an audit performed by FAS Russia

Pepeliaev Group's lawyers provided integrated legal support to a client regarding all aspects arising during the audit (inspection, interviews, and the request for documents). Based on the results of the audit, FAS Russia did not identify any signs of antitrust violations in the company's actions.

Represented a large manufacturer of floor covering during audits conducted by FAS Russia

Pepeliaev Group's lawyers conducted an in-depth analysis of the client's marketing policy as to whether the used scheme was permissible for stimulating retail stores to purchase products. We managed to correctly present the information about the client's activity and to convince the antitrust authority that the client's actions did not contain any signs of violations of antitrust legislation. As a result the antitrust authority refused to initiate a case.

Drafted objections to an audit report of the antitrust authority

The Practice's lawyers represented a major manufacturer of medicines and medical devices during an audit conducted by FAS Russia. Following the examination of the objections drafted by Pepeliaev Group's lawyers with respect to the audit report, no antitrust case relating to a violation was initiated.

Represented an international German manufacturer of electronic appliances during an audit conducted by FAS Russia

In this project the team of Pepeliaev Group's Antitrust Practice provided comprehensive support to the client which included developing a legal position and drafting objections to the audit report of the antitrust authority.

Providing representation in cases considered by the FAS

Had a cartel case successfully terminated

Several construction companies were accused of concluding a cartel agreement during a bidding process. The antitrust authority proceeded on the basis that a cartel was present based on an aggregate of traditional indirect evidence: coinciding IP addresses, a minimal decrease in the contract price, the same person preparing tender application, etc. The specialists from Pepeliaev Group's Antitrust Practice developed a protection strategy in the case and prepared detailed objections to the opinion regarding the circumstances of the case. Pepeliaev Group's lawyers managed to substantiate the position before the antitrust authority that the evidence collected by the fiscal authority does not testify to a cartel collusion. The case was terminated owing to the absence of the elements of the violation.

Prepared substantiation for the client's pricing policy: an antitrust violation case was terminated

Pepeliaev Group's lawyers prepared substantiation for the pricing policy of a Russian airline. As part of this project the lawyers of the Antitrust Practice drew up written applications and petitions, collected evidence, interacted with FAS Russia's Administration for the Republic of Tatarstan and participated in the examination of an antitrust violation case. Owing to the efforts of our lawyers the proceedings in the case were terminated.

Successfully contested a resolution to impose a fine for untrue advertising

Pepeliaev Group's lawyers successfully represented an international FMCG company before FAS Russia when the resolution was contested of the Administration of FAS Russia for the Stavropol Territory that the company should be fined for violating the requirements of Federal Law No, 38-FZ "On advertising" dated 13 March 2006. FAS Russia made claims concerning an allegedly untrue piece of advertising. Owing to the efforts of the Practice's lawyers the proceedings in the case were terminated and the resolution of the territorial administration of FAS Russia was set aside.

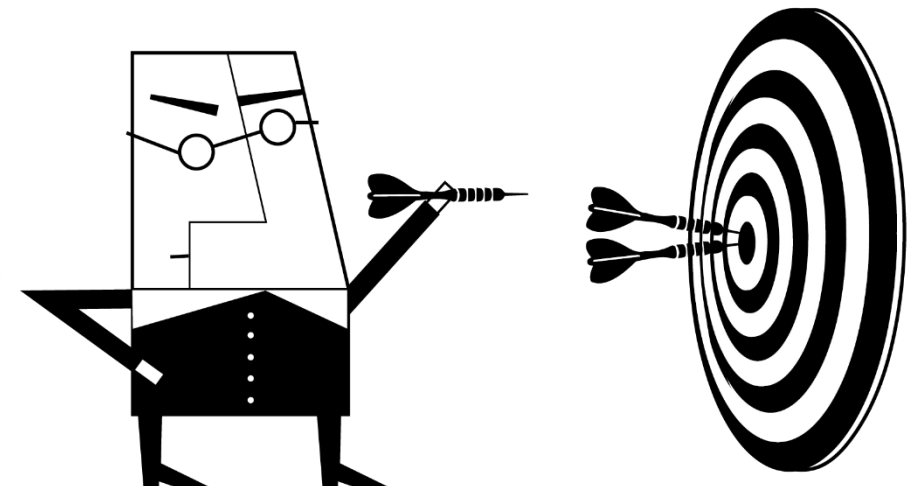

Providing legal support to clients during court disputes with FAS Russia

Successfully protected the client's interests in a case concerning the creation of discriminatory conditions

Pepeliaev Group's lawyers represented an international retail chain in a court case concerning discriminatory conditions that had been created through setting different amounts of payment for suppliers for the same marketing services. As part of the project the Practice's lawyers developed the client's legal grounds for challenging FAS's decision. We drafted a claim, additional written comments and objections to the opponent's responses during the hearing, and an appeal. Our lawyers arranged and supervised evidence gathering activities, liaised with other parties in the dispute, and represented the client during the hearings.

Built positive case law on pricing matters

The Practice's lawyers represented a large international manufacturer of potassium chloride in the State Commercial ("Arbitration") court for the City of Moscow in a dispute with FAS Russia over the invalidation of the authority's decision in a case involving a violation of antitrust legislation. This decision predetermined the pricing model for a business entity on the Russian market for the next three to five years.

Represented a client accused of having entered into a cartel agreements: the court has ruled in our favour

The Practice's lawyers represented a large transport operator that, together with ten other companies, was accused of having entered a cartel agreement and an anticompetitive agreement with a state authority. As part of the project, Pepeliaev Group's lawyers provided the following services to the client: developing a case strategy, preparing a legal position, collecting evidence, liaising with experts in economics and other participants of the case, and representing the client through all stages - before administrative liability was imposed on the client, while administrative proceedings were ongoing against it, and in court. As a result, the cassation court handed down a decision in favour of our client and the court refused to refer the case to the Judicial Panel of the Russian Supreme Court.

Providing legal assistance in government procurement and trade regulation

Advised a client regarding legislation on government procurement

Our Antitrust Practice's lawyers advised a large pharmaceutical company regarding the legislation on government procurement in connection with supplies of a medicine at the federal level. Our lawyers were also requested to represent the client during its meetings with FAS Russia and the Russian Ministry of Health to discuss the interchangeability of two medicines. The project resulted in the medicines being declared partially interchangeable, which allowed the company to continue supplying the medicine through a system of government tenders.

Represented an air carrier in a case to challenge the results of a tender

Pepeliaev Group's experts represented a Russian air carrier in a case concerning the challenging of the results of a tender and the forced conclusion of contract with such air carrier. Despite there being no well-established case law in this area, our lawyers managed to have the claim denied by the court of the first instance and court of appeal, thus creating a precedent.

Advised a client on the issues of antitrust legislation and the law on trade and represented the client before FAS Russia

Our Antitrust Practice's lawyers advised a major international retailer on issues of competition on the wholesale and retail consumer goods markets as well as on the consistency of the requirements and restrictions set by federal laws No. 135-FZ "On protecting competition" dated 26 July 2006 and No. 381-FZ "On the fundamentals of the state regulation of the trade activity in Russia" dated 28 December 2009. As part of this project our lawyers also represented the client when different territorial administrations of FAS Russia were examining cases concerning violations of the antitrust legislation.

Providing legal support in M&A transactions and in the area of international investments

Supported a client when it made a large investment in the Russian economy

The Practice's experts advised the client at each stage of obtaining from FAS Russia approval of a transaction under legislation on foreign investments in organisations of strategic significance, which included disclosing the beneficial owners and providing FAS Russia with the arguments that the transaction did not require either preliminary approval from the relevant Government Commission, or a notification of its consummation. This project was complicated because the regulator's approach was constantly changing. Our lawyers established efficient cooperation with FAS Russia which allowed the client to invest large amounts into the Russian economy.

Provided legal support while obtaining FAS Russia's approval for a joint venture agreement in the chemical industry

During the approval process, the Practice's lawyers helped the client to prove to FAS Russia that the anticompetitive provisions contained in the agreement complied with antitrust legislation and did not lead to a restriction of competition. The antitrust authority approved the entry into such agreement.

Obtained approval from FAS Russia for an acquisition of a pharmaceutical company

Pepeliaev Group's lawyers provided legal support during an acquisition by a large pharmaceutical company of another pharmaceutical company in terms of whether the acquisition complied with Russian statutory antitrust requirements. FAS Russia's approval was successfully obtained within a short time without any restrictions of a structural or behavioural nature that could have been imposed on the structure of the future company and its actions.

Providing legal support to clients as part of supranational antitrust regulation

Advised a client in the context of the antitrust legislation of the Russian Federation and of the Eurasian Economic Union

Pepeliaev Group's lawyers advised an international manufacturer of automotive vehicles on the most efficient option to build an export model of the distribution of goods taking into account the requirements of Russian antitrust legislation and the supranational competition rules of the Eurasian Economic Union.

Provided legal support to a client in terms of international rules regulating competition in the EAEU

The Practice's lawyers advised an international manufacturer of construction and other equipment on the requirements of the supranational competition legislation of the EAEU member states. Pepeliaev Group provided detailed recommendations on the most efficient ways of doing business taking into account the requirements of the supranational antitrust regulation of the EAEU.

CLIENTS HIGHLIGHT THE LAWYERS' AVAILABILITY AND PRACTICAL APPROACH, WITH ONE REMARKING THAT THE TEAM "PROVIDES COMPREHENSIVE ADVICE ON HOW TO AVOID POTENTIAL RISKS," ADDING THAT "ALL THE URGENT ISSUES WERE RESOLVED STRICTLY WITHIN THE REQUIRED TIMEFRAME."

CHAMBERS EUROPE

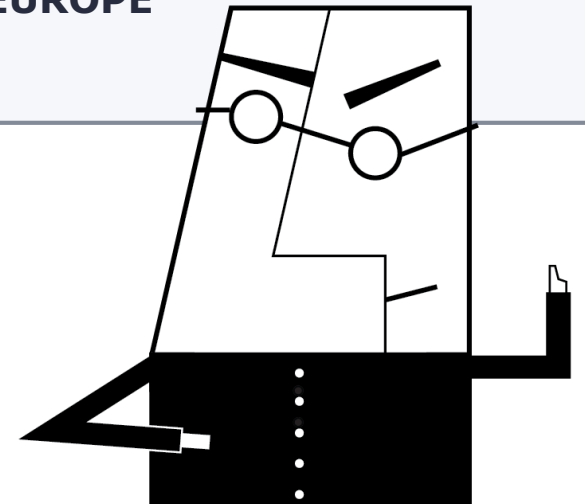

Providing legal assistance in the area of advertising

Provided legal support to the client in its marketing activities

Our Antitrust Practice's lawyers advised an international manufacturer of mobile phones and mobile equipment on matters relating to the application of advertising legislation. Our experts provided legal support for the client's marketing activities, its creation of advertising slogans, and other issues.

Advised the client on mitigating risks when publishing advertising materials

Pepeliaev Group's lawyers advised a large online recruitment company as to whether the materials published on its website were in compliance with advertising legislation. Our lawyers provided recommendations on how to mitigate risks in the context of prohibitions on the distribution of goods the advertising of which is prohibited or restricted.

Represented a client with regard to the distribution of inappropriate advertising

Our lawyers advised an international toy manufacturer on potential violations by third parties of the lawful rights and interests of the company by the distribution of inappropriate advertising and also through unfair competition.

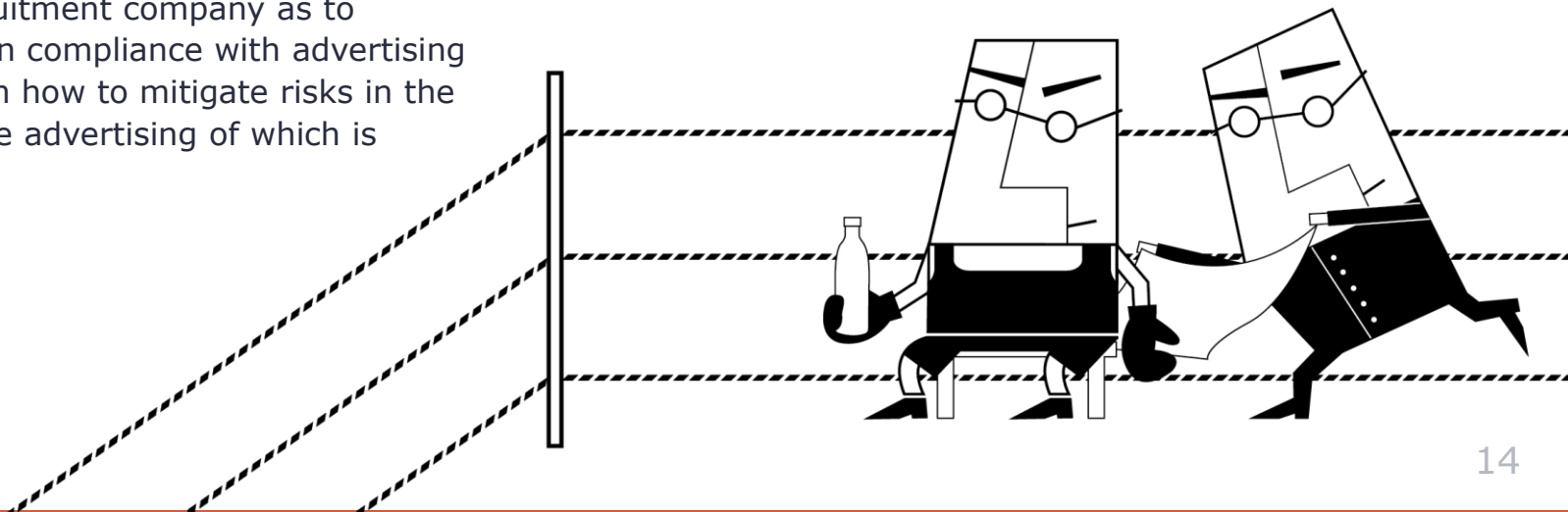

The team



Elena Sokolovskaya

Partner

e.sokolovskaya@pgplaw.ru



Elena has been specialising in the area of antitrust legislation for more than 20 years. She has extensive experience of representing clients before FAS Russia and the Eurasian Economic Commission and in courts on all cases that fall within the jurisdiction of FAS Russia and the Eurasian Economic Commission. Elena is a member of the Competition Experts Association and of the not-for-profit partnership "Competition Support in the CIS Countries".

She obtained her Postgraduate Diploma in European Competition Law at King's College (London).

WHAT THEY SAY

Chambers Europe: "The practice specialises in interacting within the industry; sources note the 'excellent organisation of conferences and workshops involving representatives of regulatory bodies'".

"THE TEAM IS KNOWN FOR ITS STRENGTH IN ADVISORY SERVICES."

CHAMBERS EUROPE

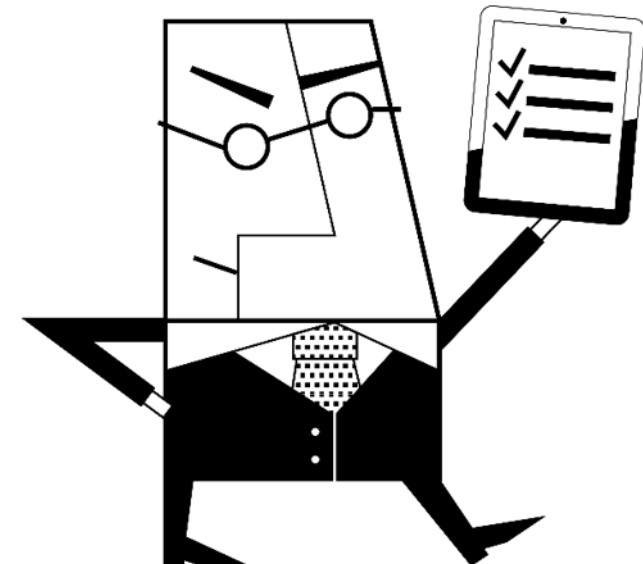

About the firm

A leading Russian law firm offering the full range of legal services.

Lawyers

160



Our lawyers include
3 Doctors of Laws
and 19 PhDs in Law.



Clients

2000

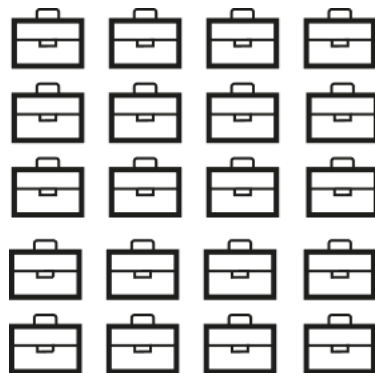

Office

6

Moscow
St Petersburg
Nizhnekamsk
Krasnoyarsk
Vladivostok
Dubai

Developing Eastwards

- Chinese Desk
- Korean Desk

Ratings



CHAMBERS
EUROPE

CHAMBERS
GLOBAL

IFLR1000

World
Trademark
Review.

INTERNATIONAL
TAX REVIEW



Best Lawyers

@PGP_OFFICIAL

News of the firm, themed overviews of legislation and administrative and judicial practice, and expert commentary

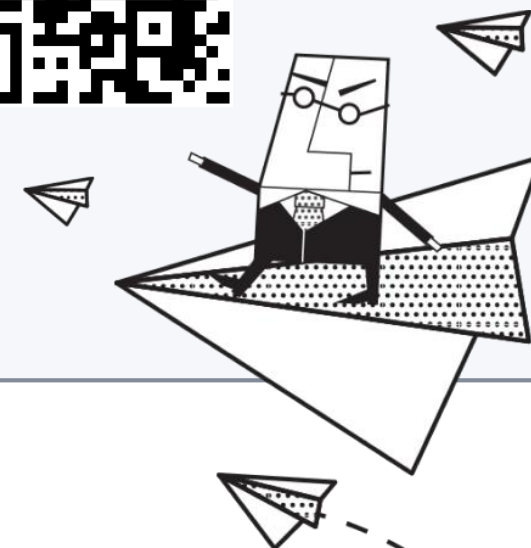

Services



Tax advice &
tax disputes



Administrative law
defence of business



Banking and
finance practice



Bankruptcy



Family and
inheritance law



Employment and
migration law



Customs law and
foreign trade
regulation



Currency regulation
and currency control



International litigation
and arbitration



Corporate law / M&A



Antitrust regulation



Dispute resolution
and mediation



Criminal law defence
of business



Legal protection
of information



Real estate & construction



Intellectual property
and trademarks



Environment



Telecommunications,
media and IT



Digital group



Life sciences

Geographical coverage

Chinese Desk

- Support for Chinese investors in Russia and for Russian investors in China.
- We have strategic partners on the Chinese market.
- Comprehensive legal support.

Korean Desk

- Legal advice to Korean companies in Russia and to Russian investors in Korea.

Middle East Desk

- PG TAX Consultancy LLC provides services on tax structuring and tax consultancy in UAE and GCC.

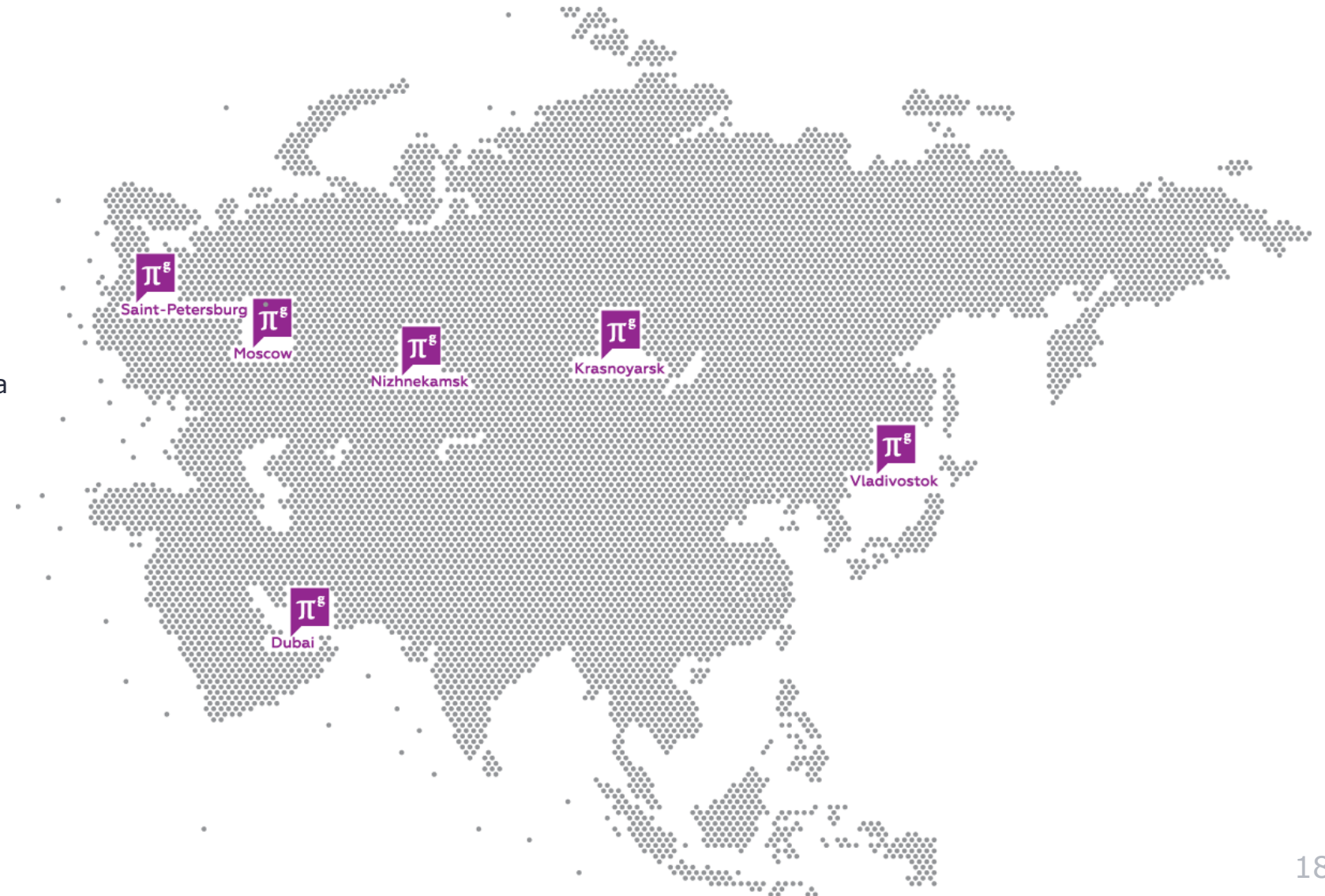

Contacts

Moscow

E: info@pgplaw.ru

Tel.: +7 (495) 767-00-07

St Petersburg

E: spb@pgplaw.ru

Tel.: +7 (812) 640-60-10

Tatarstan, Nizhnekamsk

E: rt@pgplaw.ru

Tel.: +7 (495) 767-00-07

Krasnoyarsk

E: krs@pgplaw.ru

Tel.: +7 (391) 277-73-00

Vladivostok

E: vld@pgplaw.ru

Tel.: +7 (4232) 65-93-55

UAE, Dubai

E: info@pgplaw.ae

Tel.: +971 54 417 3060

China

E: cn@pgplaw.ru

T: +7 (495) 767-00-07

Korea

E: kor@pgplaw.ru

T: +7 (495) 767-00-07

www.pgplaw.ru